

General specifications

Layout

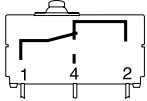

Components

Material

- Case : UL 94VO glass-filled polyester
- Button : Polyester
- Membrane : silicon
- Contacts : AgCdO
AgNi (dual current),
- Terminals : tinned brass
- Cable : PVC (IP 67)
- Leads : PVC

Actuators

- flat : stainless steel
- roller : stainless steel with polyamide roller

Approvals 83 180/83 186 : NF. UL - cUL on request

Operating curve 250 V~

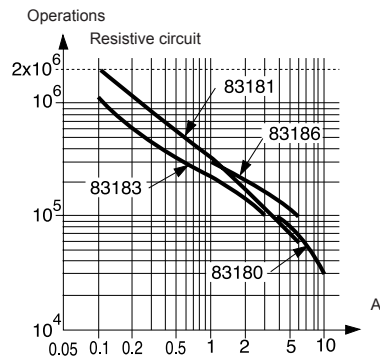

Switch rating with DC supply

		83 180	83 181	83 183	83 186	
12 V	Resistive load	10 A	6 A	3 A	6	A
	Inductive	10 A	6 A	3 A	6	A
	L/R 5 ms	10 A	6 A	3 A	6	A
24 V	Resistive load	10 A	6 A	3 A	6	A
	Inductive	5 A	5 A	3 A	5	A
	L/R 5 ms	5 A	5 A	3 A	5	A

Model 83 181 is designed to operate equally well on dual-current (1 mA 4 V minimum) or medium-current (6 A maximum) circuits. However, a given product should only be used to switch one type of circuit during its working life.

Degree of protection

- Tag version : casing = IP67
terminals = IP00
- Lead / cable version : outlet / casing = IP67

Types

Part numbers for standard products with connection of type

1
2
FD0

Features

Electrical characteristics

Current rating at 250 V	Nominal Hp	A
		1/2

Mechanical characteristics

Operating force - max.		N (oz.)
Release force - min.		N (oz.)
Total travel force - max.		N (oz.)
Permitted overtravel force - max.		N (oz.)
Rest position - max.		mm (in.)
Tripping point		mm (in.)
Differential travel		mm (in.)
Overtravel - min.		mm (in.)
Ambient operating temperature	for tag version	°C (°F)
	for lead / cable version	°C (°F)
Mechanical durability		Operations
Contact gap		mm (in.)
Weight (tag version)		g (oz.)

Contact Type

C (Form C) SPDT

B (Form B) SPNC not available in PC terminals

A (Form A) SPNO not available in PC terminals

Connections



Actuators and mounting positions

Part numbers for standard actuators

Actuators - Length mm (in.)

Mounting position

Coefficient

Tripping point mm (in.)

83 180

83 181/183/186

Part numbers for standard actuators

Actuators - Length mm (in.)

Mounting positions

Coefficient

Tripping point

Except where otherwise indicated, actuators are supplied unmounted.

For factory mounting, specify fixing position L or R.

- **To calculate force** : take the force quoted for the switch and divide by the coefficient given in the table.

- **To calculate travel** : take the travel quoted for the switch and multiply by the same coefficient.

Mounting accessories for PCB mounting : 5 / 6 / 7 / 8

See page 3/9.

Other information

For other forces, actuators, connections and temperatures, please consult us.

Normally stocked items

Catalog products produced to order

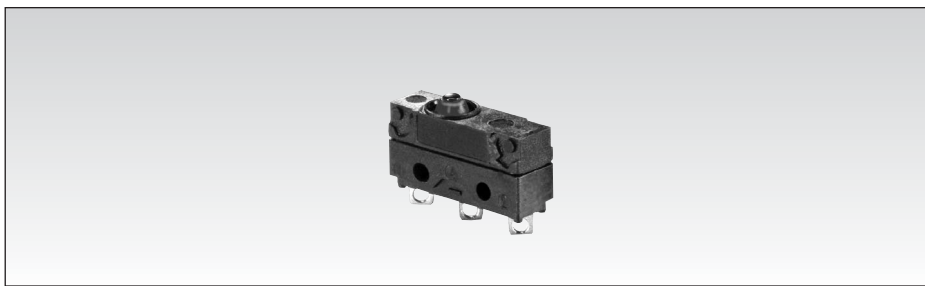

83180	83181	83183	83186
831800C1.0	831810C1.0	831830C1.0	831860C1.0
831800C2.0	831810C2.0	831830C2.0	831860C2.0
831800CFD0.0	831810CFD0.0	831830CFD0.0	831860CFD0.0

High current	Dual current	Medium current	Standard
10	6	3	6
12.5	7.5	4	7.5
3.4 (12)	2.5 (8.8)	2.5 (8.8)	2.5 (8.8)
1 (3.5)	0.8 (2.8)	0.8 (2.8)	0.8 (2.8)
5 (17.6)	4.2 (14.1)	4.2 (14.1)	4.2 (14.1)
10 (35.3)	10 (35.3)	10 (35.3)	10 (35.3)
9.3 (.37)	9.3 (.37)	9.3 (.37)	9.3 (.37)
8.4 ±0.3 (.33 ±0.012)	8.4 ±0.3 (.33 ±0.012)	8.4 ±0.3 (.33 ±0.012)	8.4 ±0.3 (.33 ±0.012)
0.10 (.004)	0.10 (.004)	0.10 (.004)	0.10 (.004)
0.6 (.024)	0.6 (.024)	0.6 (.024)	0.6 (.024)
-40 +125 (-40 +257)	-40 +125 (-40 +257)	-40 +125 (-40 +257)	-40 +125 (-40 +257)
-40 +105 (-40 +221)	-40 +105 (-40 +221)	-40 +105 (-40 +221)	-40 +105 (-40 +221)
10 ⁶	2 x 10 ⁶	2 x 10 ⁶	2 x 10 ⁶
0.4 (.016)	0.4 (.016)	0.4 (.016)	0.4 (.016)
2 (.07)	2 (.07)	2 (.07)	2 (.07)

C	C	C	C
B	B	B	B
A	A	A	A

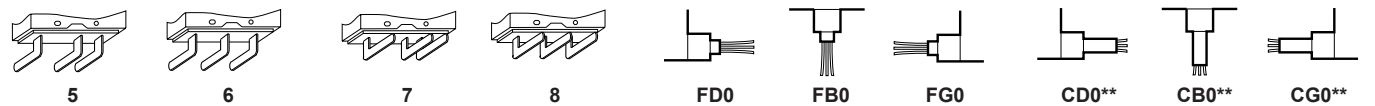

A 79 253 327	B 79 253 326	C 79 253 328	E 79 218 454
Flat 170A R18.3 (.72)	Flat 170A R24 (.94)	Flat 170A R41 (1.61)	Roller 170E R20 (.79)
L 3 10.4 ^{+1.2} (.41 ^{+0.05})	L 4 11.1 ^{+1.2} (.44 ^{+0.05})	L 7 13.2 ^{+2.5} (.52 ⁺¹)	L 3 15.4 ^{+1.2} (.61 ^{+0.05})
R 1.5 9.2 ^{+0.6} (.36 ⁺²⁴)	R 2 9.6 ^{+0.6} (.38 ^{+0.04})	R 3.5 10.7 ^{+1.2} (.42 ^{+0.05})	R 1.5 14.5 ^{+0.6} (.57 ⁺²⁴)

F 79 253 329	D *	L *
Dummy roller 170F R19.5 (.77)	Screw 170D	Transverse roller 170EL *
L 3 13 ^{+1.2} (.51 ^{+0.05})		
R 1.5 12 ^{+0.6} (.47 ⁺²⁴)		

Ø No Actuator

* Special order, contact us for part number
 ** Cable version for types 83 181, 83 183 and 83 186

To order please specify :

1 Switch Type 831810 831830 831860 831800	2 Contact Type A B C	3 Connection 1 6 2 7 3 8 4 FDØ CDØ 5 FGØ CBØ FBØ CGØ	4 Actuators Ø A B C D E	5 Actuator Position L - Left (Standard) R - Right
--	--------------------------------------	---	--	--

To order actuators separately, use the 8 digit P/N

Example P/N is 831810 SPDT solder terminals with no actuator.

Products and specifications subject to change without notice.

Sealed Subminiature Switches DIN 41635 B

Dimensions

Symmetric

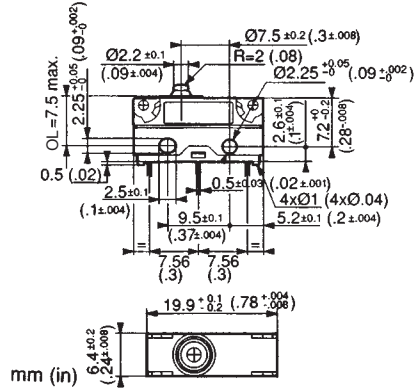

Asymmetric

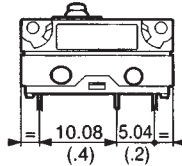

Fixed by 2 x M2 screws
Torque for screw alone: 0.2 Nm (1.75 in. lbs.)
screw + washer: 0.3 Nm (2.65 in. lbs.)

Connections

Terminals

2 Solder

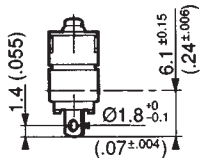

1 Faston 2.8 x 0.5 .110" Quick Connects

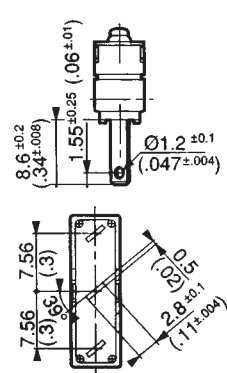

3 - 4 Straight PCB output

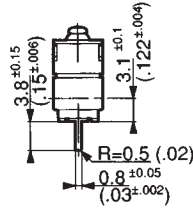

5 - 6 Side output, PCB rear

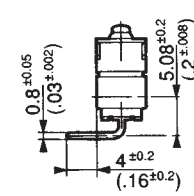

7 - 8 Side output, PCB front

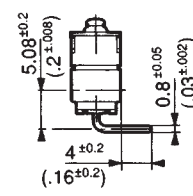

Printed circuit board mounting

Asymmetric 3, 5, 7

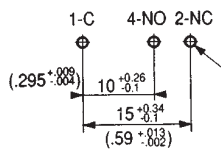

Symmetric 4, 6, 8

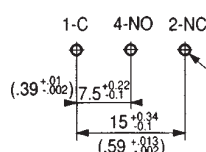

Mounting on a printed circuit board with mounting pins

Asymmetric

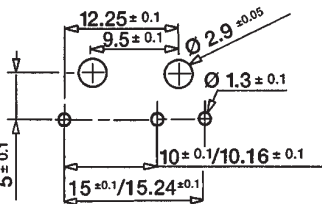

Symmetric

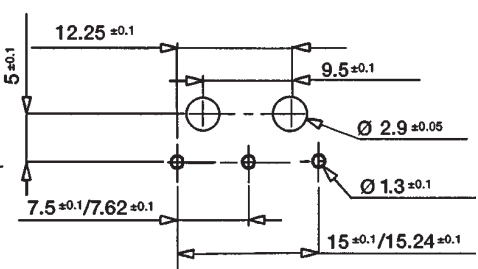

Lead output

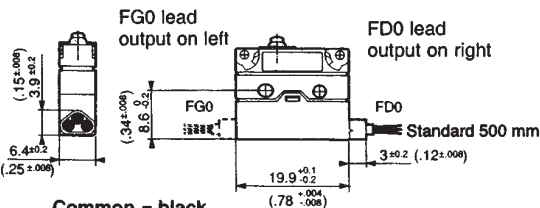

Common = black
NC = brown
NO = blue
mm (in)

Conductor cross-section :
83181 / 83183 / 83186 = 3×0.5 mm² ($.12 \times .02$ in²)
83180 = 3×0.75 mm² ($.12 \times .03$ in²)

Mounting pins

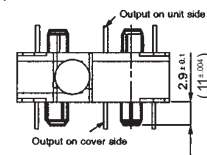

Products and specifications subject to change without notice.

Cable output

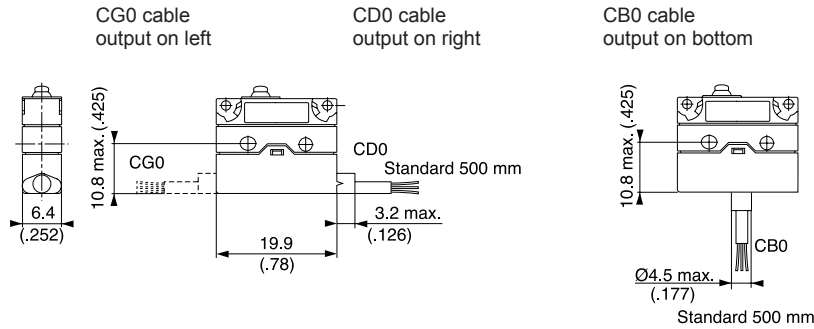

Conductor cross-section :
 83181 / 83183 / 83186 = 3 x 0.5 mm²
 (.12 x .02 in²)

Common = black
 NC = brown
 NO = blue

mm (in.)

Actuators

Mounting positions

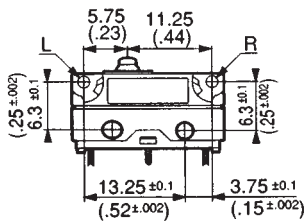

A, B, C
Flat

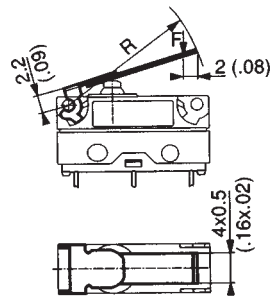

E
Roller

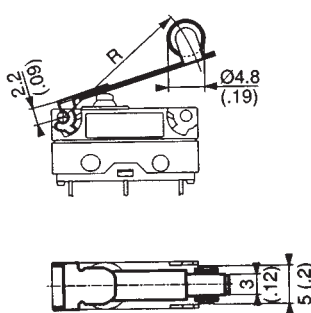

F
Dummy roller

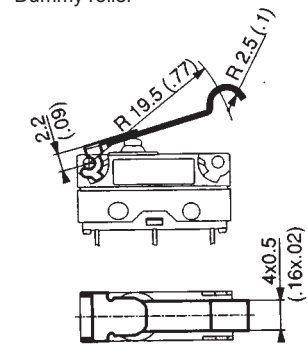

mm (in.)

Recommendations for operation from the side

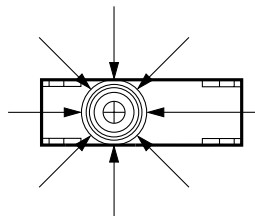
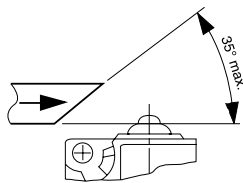

Products and specifications subject to change without notice.